



LJ148-70
LG148-70

4" Centerset Lavatory Faucet
Grifo central de 4 pulg. para el baño
Robinet pou lavabo centré de 4 po.

Quick Installation Guide
Guía de instalación rápida
Guide d'installation rapide

Installation Support • Soporte de instalación • Support d'installation

Personal Assistance, Product Specs, & "How-to" Questions:

Asistencia personal, especificaciones del producto y preguntas sobre "cómo hacerlo":
Aide personnelle, spécifications du produit et questions « pratique-pratiques » :

1-800-PFAUCET (732-8238)
pfisterfaucets.com/support

Installation Videos Available
Videos de instalación a disposición
Vidéos d'installation disponibles



pfisterfaucets.com/videos



WARNING / ADVERTENCIA / AVERTISSEMENT

To reduce the risk of injury or property damage, read all instructions before installing product. Wear safety goggles. Product must be installed in accordance with all state & local plumbing & building codes. Call a professional if you are uncertain about installing this product.

Para disminuir el riesgo de lesiones o daños a la propiedad, lea todas las instrucciones antes de instalar el producto. Utilice gafas de seguridad. El producto deberá instalarse de acuerdo con la normativa de plomería y construcción estatal y local. Llame a un profesional si no está seguro sobre cómo instalar este producto.

Pour réduire le risque de blessures ou de dommages, lire toutes les instructions avant d'installer le produit. Porter des lunettes de sécurité. Le produit doit être installé en conformité avec tous les codes de construction et de plomberie locaux et de l'état. Appelez un professionnel si vous n'êtes pas certain de la façon d'installer ce produit.

Required Tools
Herramientas necesarias
Outils nécessaires

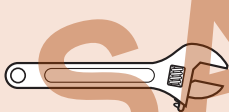

Adjustable Wrench
Llave ajustable
Clé à molette



Plumber's Putty
Masilla para plomería
Mastic de plombier



Safety Goggles
Gafas de seguridad
Lunettes de sûreté

Additional Helpful Tools
Otras herramientas útiles
Outils supplémentaires utiles

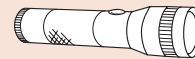

Flashlight
Linterna
Lampe-torche



Cloth
Paño
Chiffon

Parts in the Box
Piezas en la caja
Pièces dans la boîte

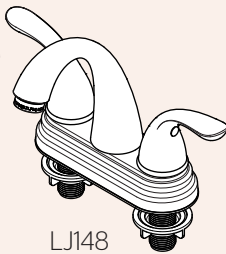

LJ148

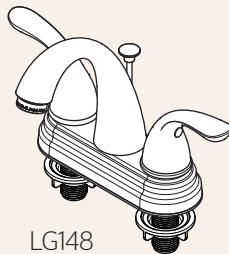

LG148



B (x2)



LJ148



LG148



LG148



D

1 Turn Off Water Supply • Cierre el suministro de agua • Couper l'alimentation en eau



Locate water supply inlets and shut off the water supply valves. These are usually found under the sink or near the water meter. If you are replacing an existing faucet, remove the old faucet from the sink and clean the sink surface thoroughly.

Ubique las entradas del suministro de agua y cierre las válvulas de suministro de agua. Generalmente se encuentran debajo del fregadero o cerca del medidor de agua. Si se trata de un reemplazo de grifo, quite el grifo viejo y limpie completamente la superficie del fregadero.

Recherchez les entrées d'approvisionnement et fermez leurs robinets. Ces robinets se trouvent généralement sous l'évier ou près du compteur d'eau. Si vous remplacez un robinet existant, retirez, le vieux robinet de l'évier et nettoyez soigneusement la surface de ce dernier.

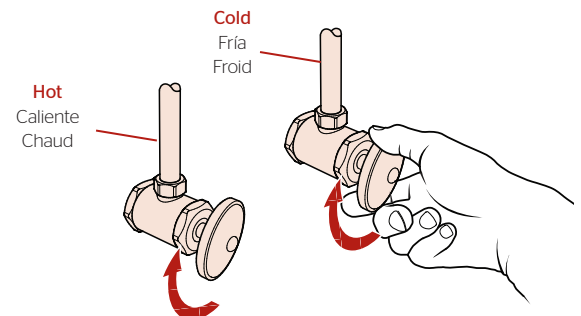

2 Install Faucet Instale el grifo Installez le robinet



Plumber's Putty
Masilla para plomería
Mastic de plombier

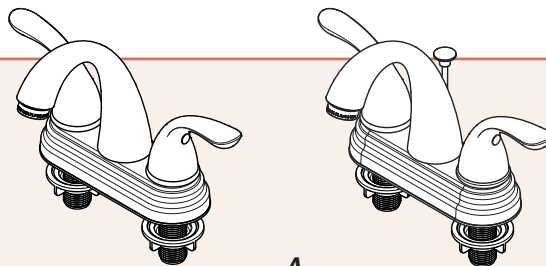

2A Disassemble Desensamble Démontez

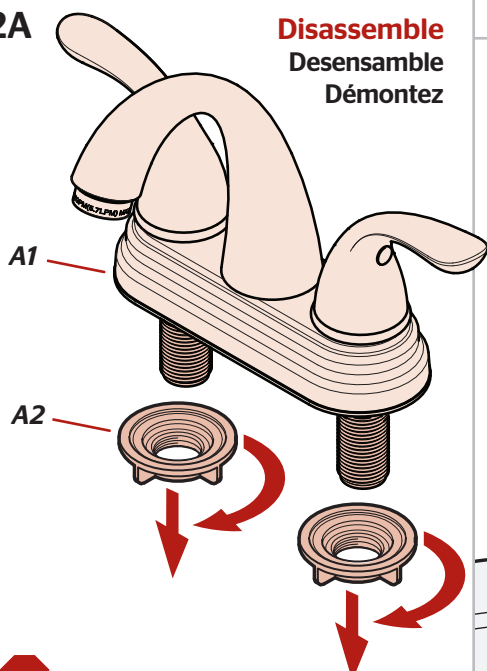

Save for step 3.

Reserve para el paso 3.
Conservez pour l'étape 3.



A2 (X2)

2B

Apply Plumber's Putty in the groove along the bottom outer edge of Plate (A3).

Aplique masilla de plomería en la ranura a lo largo del borde exterior de la placa inferior (A3).

Appliquez du mastic de plombier dans la rainure sur le bord extérieur de la plaque (A3).

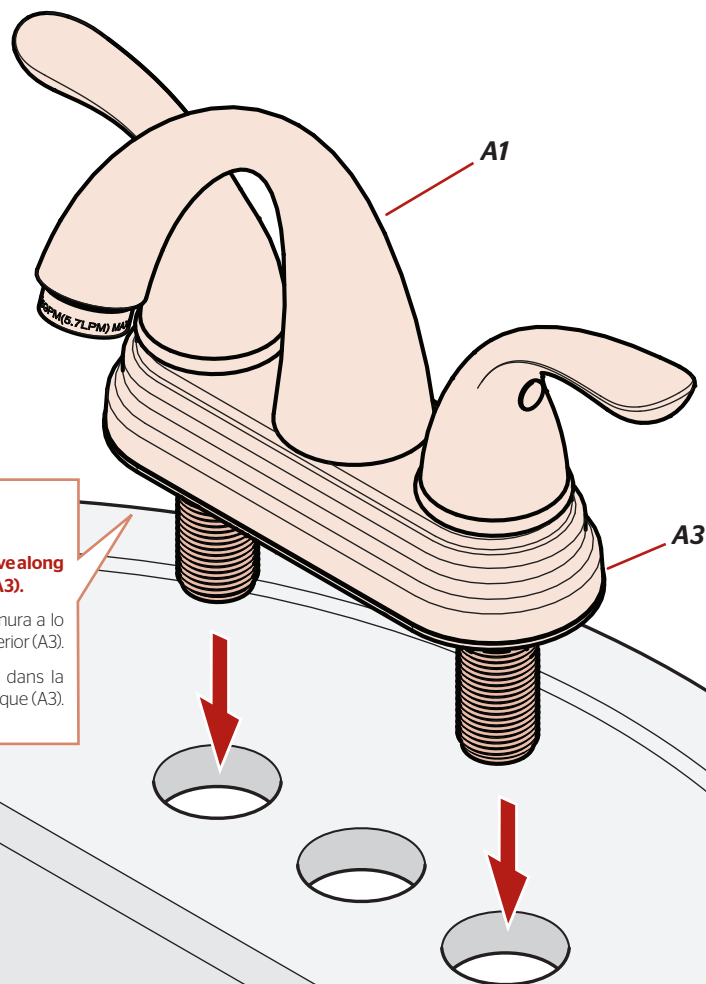

2C: ONLY FOR LG148

Solo Para LG148

Juste Pour LG148

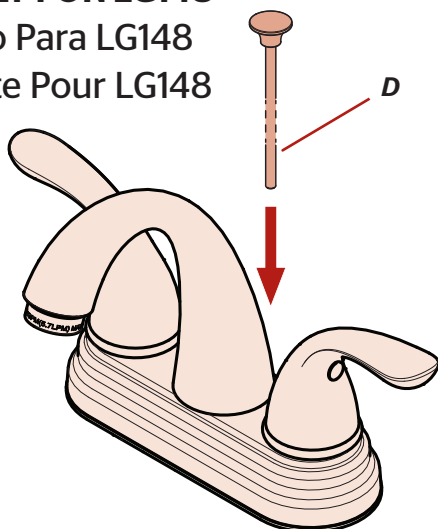

3

Secure Faucet Asegure el grifo Fixez le robinet

No Tools Required for This Step
No se necesitan herramientas para este paso
Pas d'outil nécessaire pour cette étape



A2 (X2)

From Step 2A
Desde el paso 2A
De l'étape 2A

3

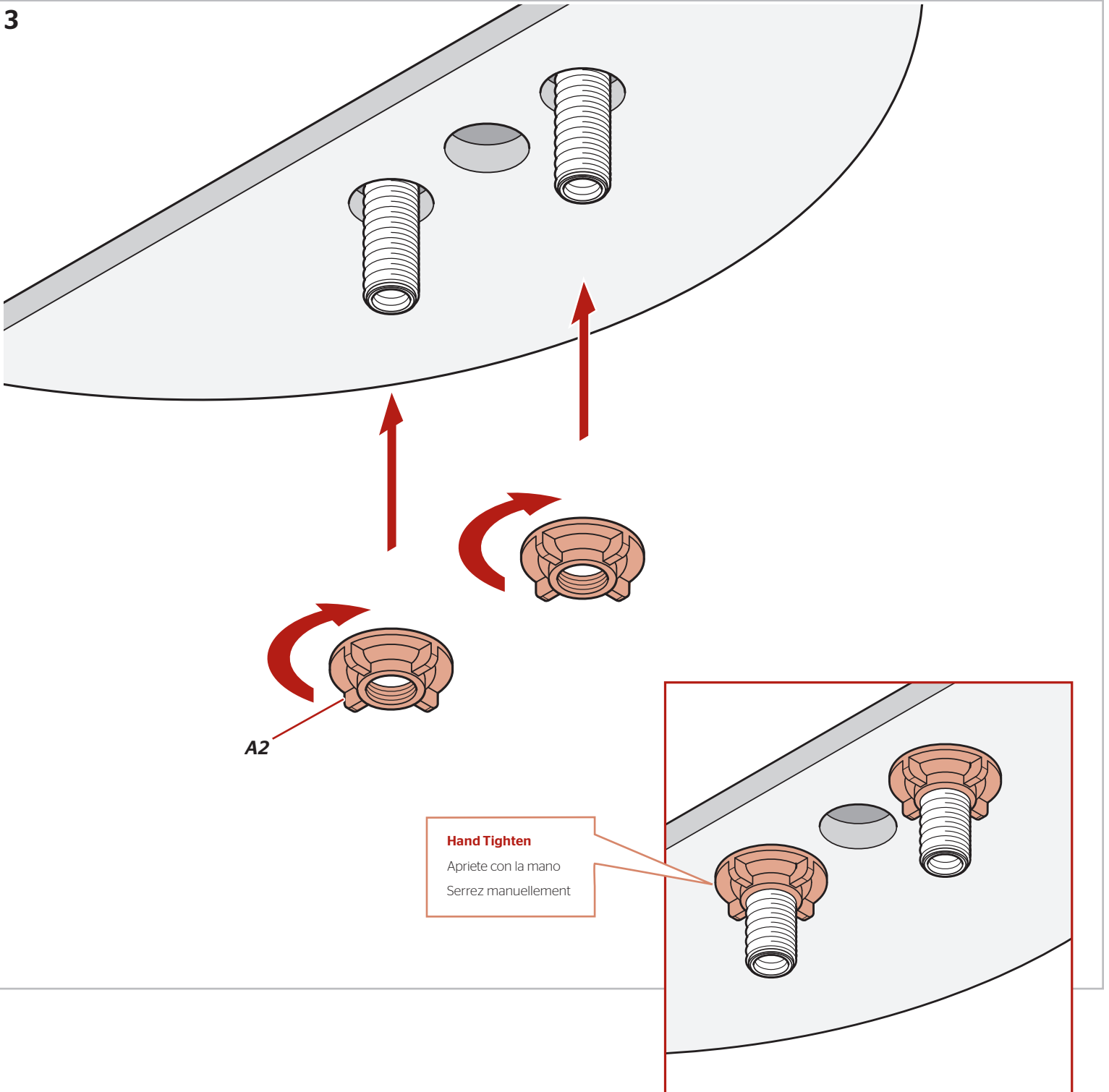

4 Connect Water Supply Lines Conecte las tuberías de suministro de agua Raccorder les conduites d'alimentation en eau

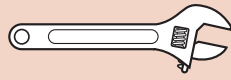

Adjustable Wrench
Llave ajustable
Clé à Mollette

No Parts Required for This Step
No se necesitan piezas para este paso
Aucune pièce nécessaire pour cette étape

! Water Supply Lines not included. Please consult manufacturer and/or its instructions for the correct method of installation of supply lines & fittings. **IMPORTANT: Incorrect application of supply lines and fittings may result in the failure or leak of the supply lines and fitting.**

Las tuberías de suministro de agua no están incluidas. Consulte por favor el fabricante y/o sus instrucciones para el método correcto de instalación de líneas de suministro y de guarniciones.

IMPORTANT: El uso incorrecto de líneas de suministro y de guarniciones puede dar lugar a la falta o al escape de las líneas de suministro y de la guarnición.

Les tuyaux d'arrivée d'eau ne sont pas fournis. Veuillez consulter le fabricant et/ou ses instructions pour la méthode correcte d'installation des conduites d'alimentation en eau et des accessoires.

IMPORTANT: Mauvaise application des lignes d'alimentation et accessoires peut entraîner la défaillance ou la fuite.

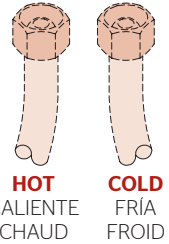

4

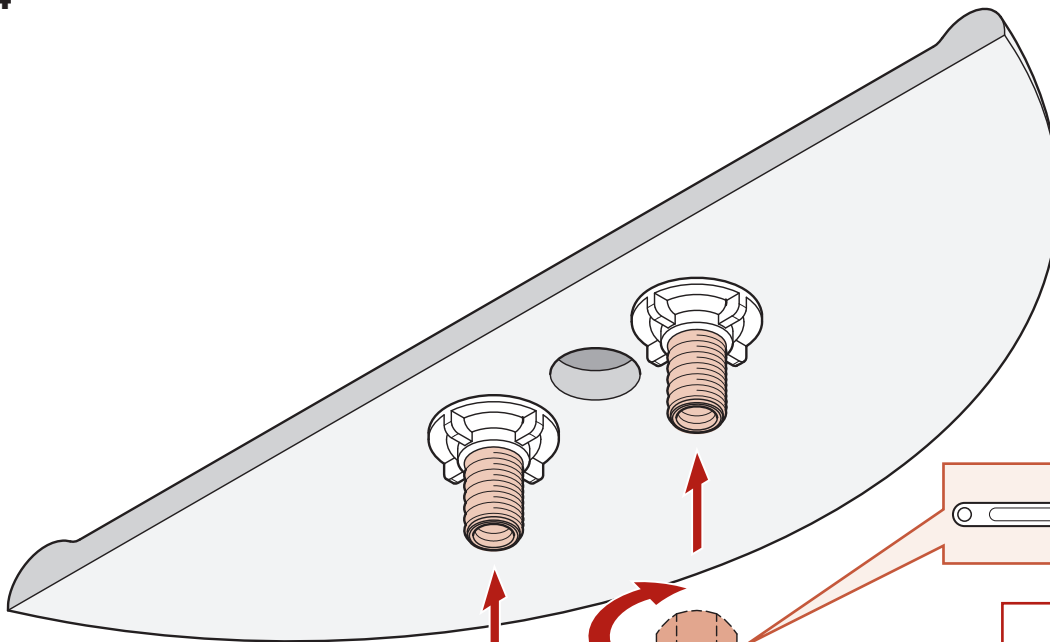

Water supply line
Línea de suministro del agua
Ligne d'approvisionnement en eau

HOT
CALIENTE
CHAUD

COLD
FRÍA
FROID

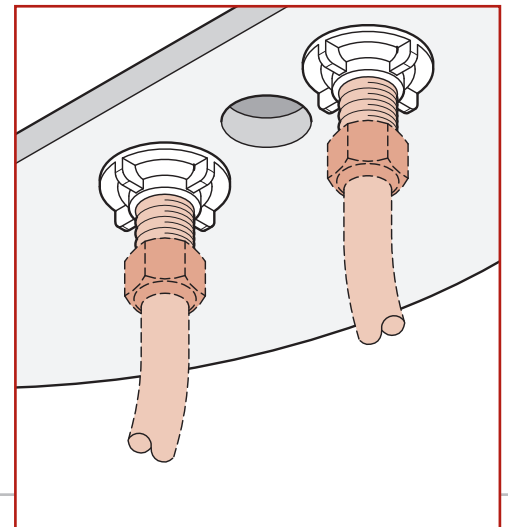

5 LG148-70 ONLY: Prepare & Install Pop-Up
Solo Para LG148-70: Prepare e instale el tapón retráctil
Juste Pour LG148-70: Préparez & installez le bouchon à clapet

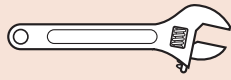

Adjustable Wrench
Llave ajustable
Clé à Mollette



Plumber's Putty
Masilla para plomería
Mastic de plombier

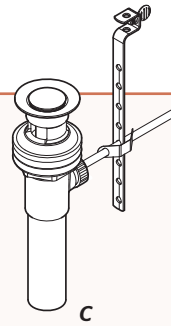

C

5A Disassemble Pop-up Assembly
Desensamble el ensamble del tapón retráctil
Démontez l'ensemble bouchon à clapet

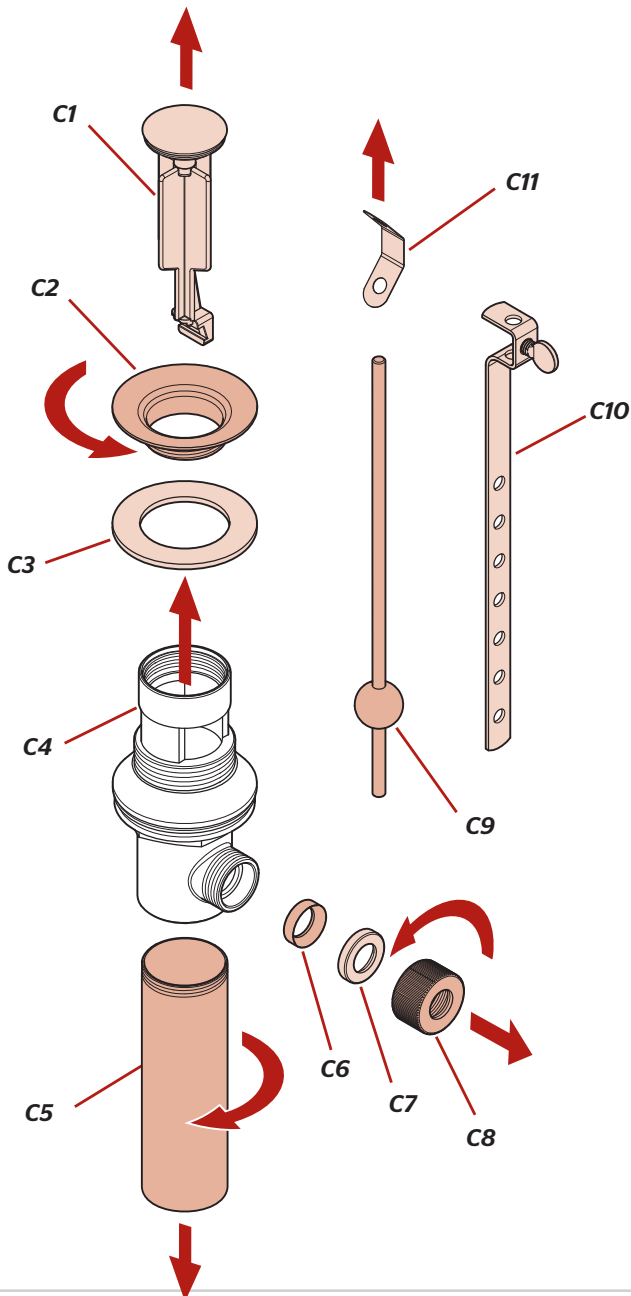

5B

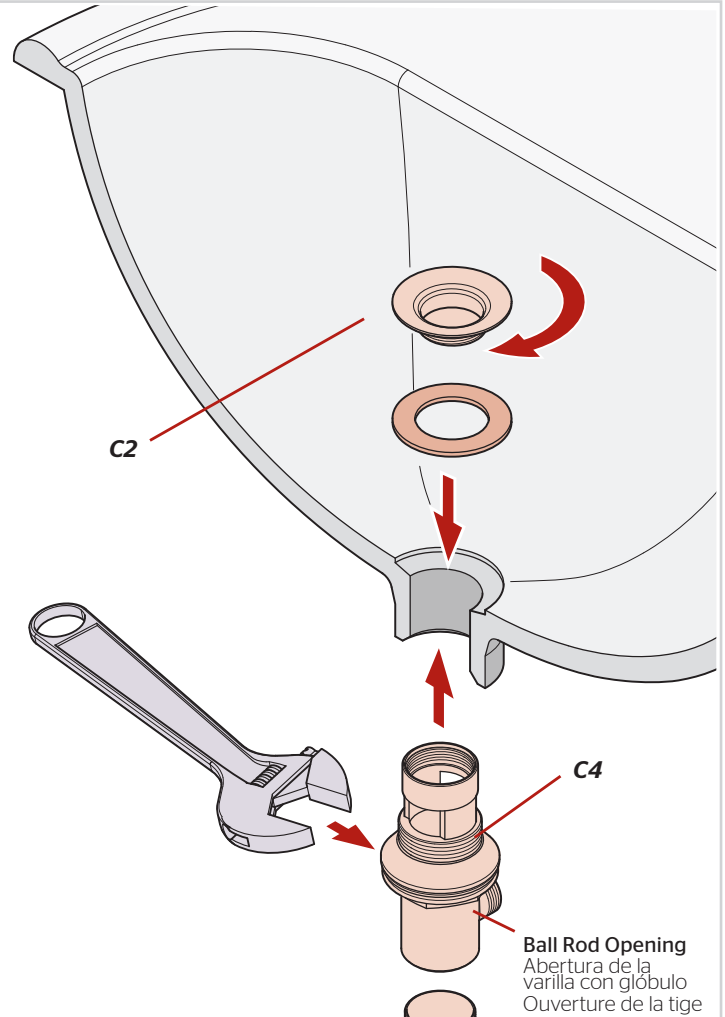

Screw Drain Body (C4) to bottom of Flange (C2) and adjust so that ball rod opening faces rear.

Enrosque la estructura de desagüe (C4) a la parte inferior de la pestaña (C2) y ajuste de modo que la abertura de la varilla con glóbulo esté orientada hacia la parte posterior.

Vissez le corps du renvoi (C4) au bas de la bride (C2) et réglez de façon à ce que l'ouverture de la tige soit tournée vers l'arrière.

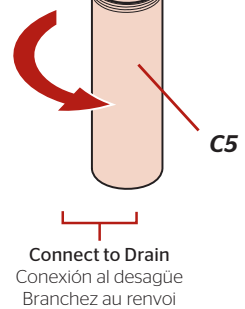

Connect to Drain
Conexión al desagüe
Branchez au renvoi

6 LG148-70 ONLY: Prepare & Connect Lift Rod

Solo Para LG148-70: Prepare y conecte la varilla de elevación

Juste Pour LG148-70: Préparez & connectez la tige levier

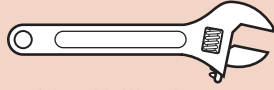

Adjustable Wrench
Llave ajustable
Clé réglable

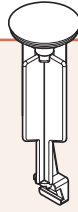

C1

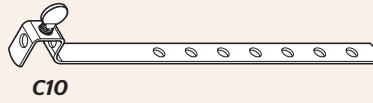

C10



C9



C11



C6



C7



C8

6A

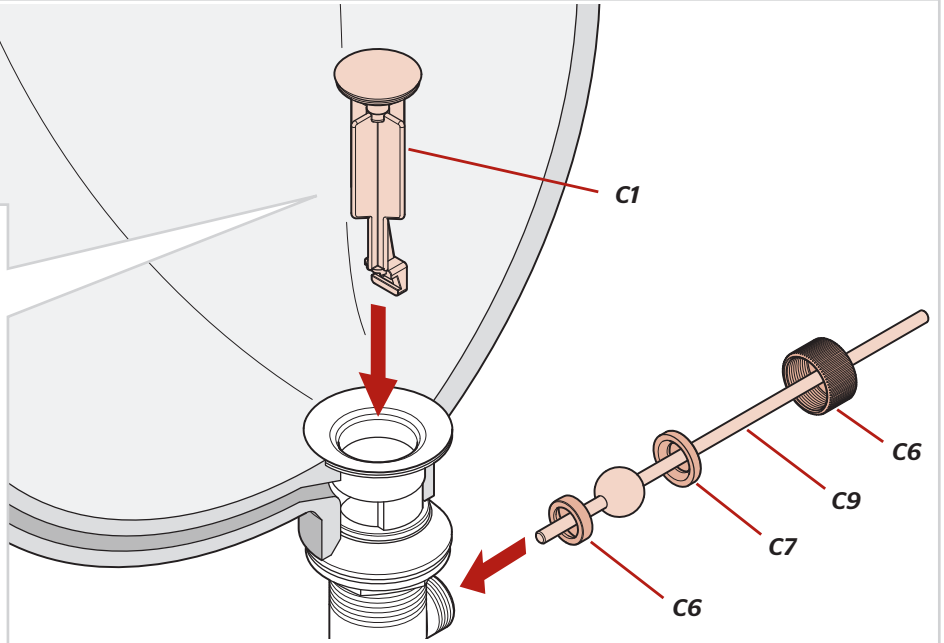
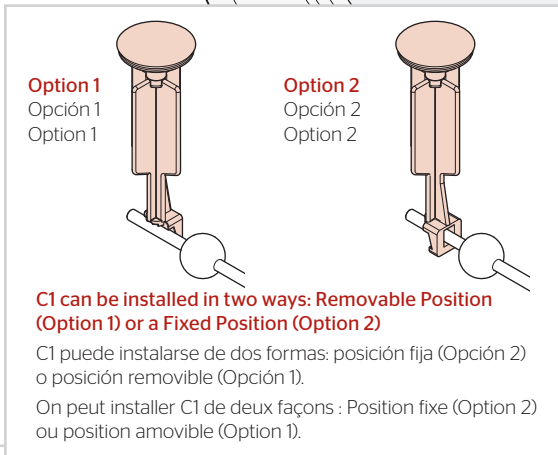

6B Assemble Lift Rod Connection

Ensamble de la conexión de varilla de elevación

Assemblez la connexion de la tige levier

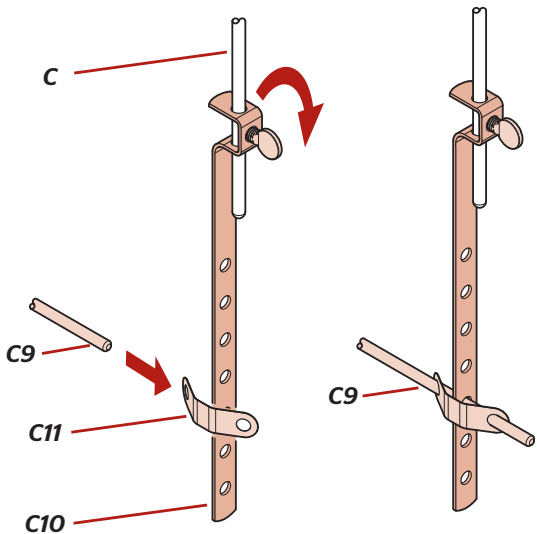

6C Pop-Up Completion

Finalización de la instalación del tapón retráctil

Terminer le bouchon à clapet

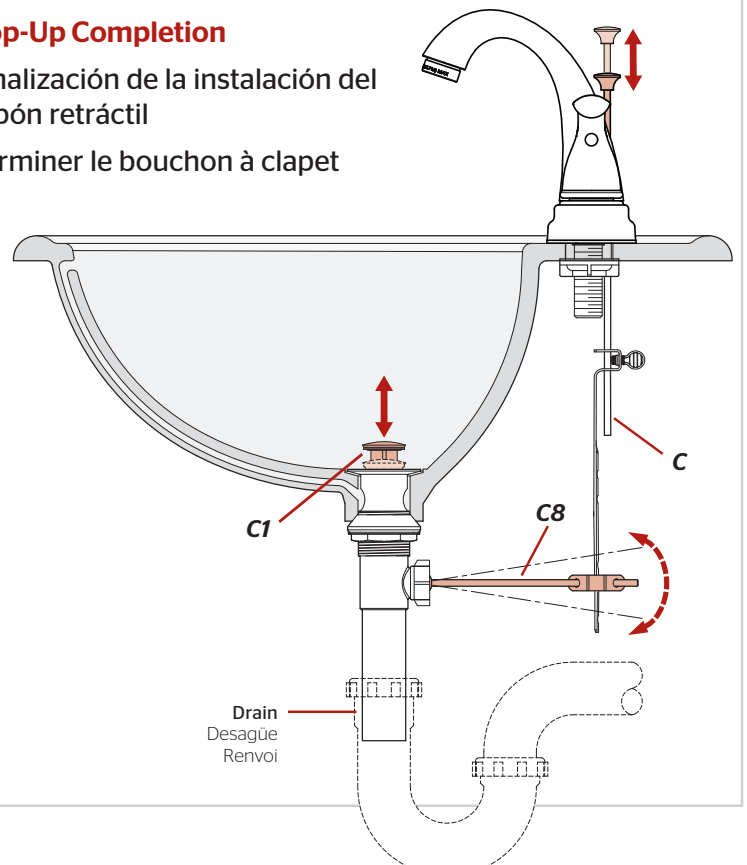

7 LJ148-70 ONLY: Prepare & Install Push & Seal™ Drain

Solo Para LJ148-70: Prepare y instale cuerpo de drenaje Push & Seal™

Juste Pour LJ148-70: Préparez & installez le corps de drainage Push & Seal™

No Tools Required for This Step
No se necesitan herramientas para este paso
Pas d'outil nécessaire pour cette étape



7A Disassemble Pop-Up Desensamble el cuerpo de drenaje Démontez le corps de drainage

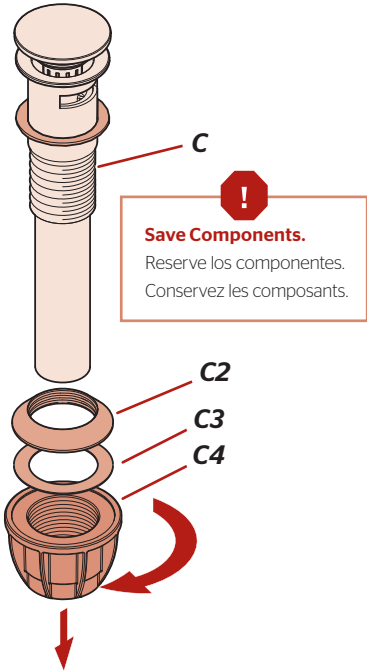

7B

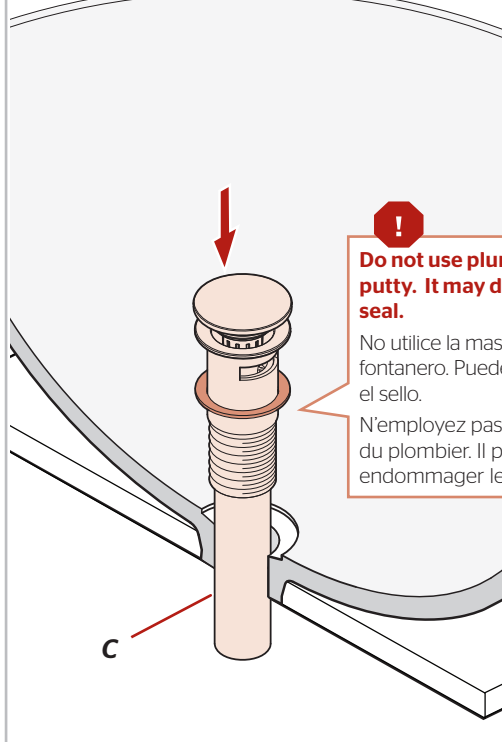

7C

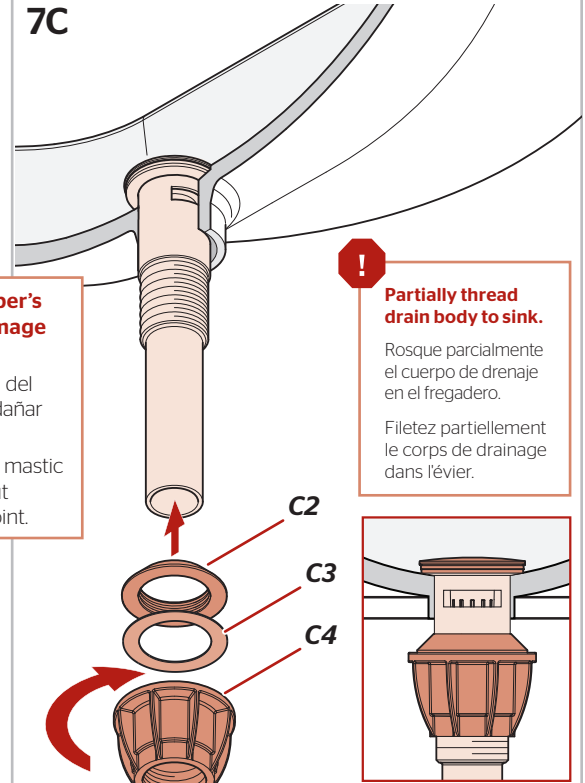

7D

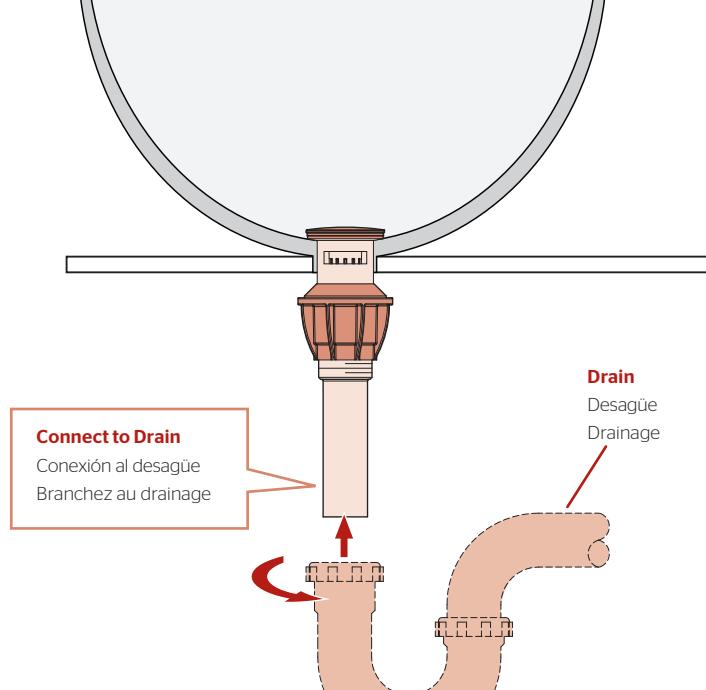

7E

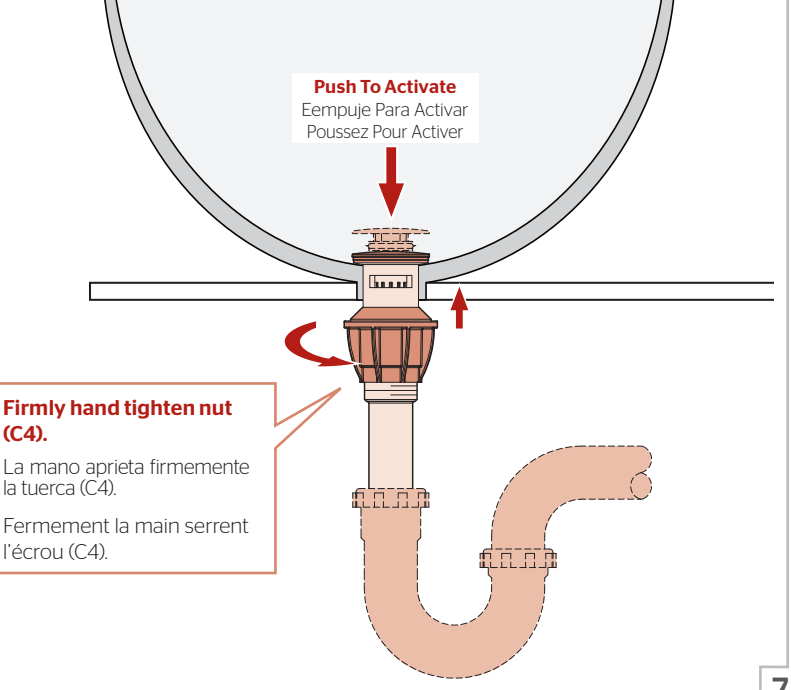

8

Turn On Water & Confirm Proper Installation

Active el suministro de agua y confirme que la instalación es adecuada

Ouvrez l'eau et confirmez que l'installation est correcte

8A

Remove Aerator

Retire el aereador

Retirez l'aérateur

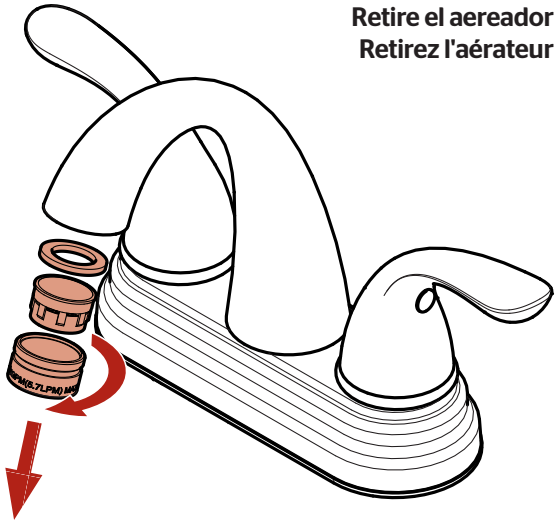

8B

Turn On Water Supply

Abra el suministro de agua

Ouvrez l'alimentation en eau

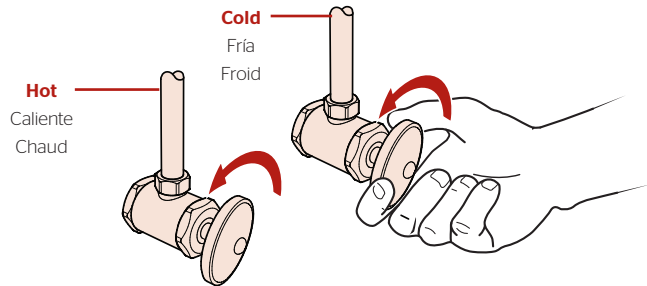

Check for leaks above and below the sink.

Revise si hay fugas encima y debajo del fregadero

Assurez-vous qu'il n'y a pas de fuite au dessus ou au dessous du lavabo.

8C

Open

Abierta
Ouvverte

Hot

Caliente
Chaud

Turn On Faucet

Active el grifo

Ouvrez le robinet

Cold

Fria
Froid

Open

Abierta
Ouvverte

Open Slowly

Abra lentamente
Ouvrez lentement

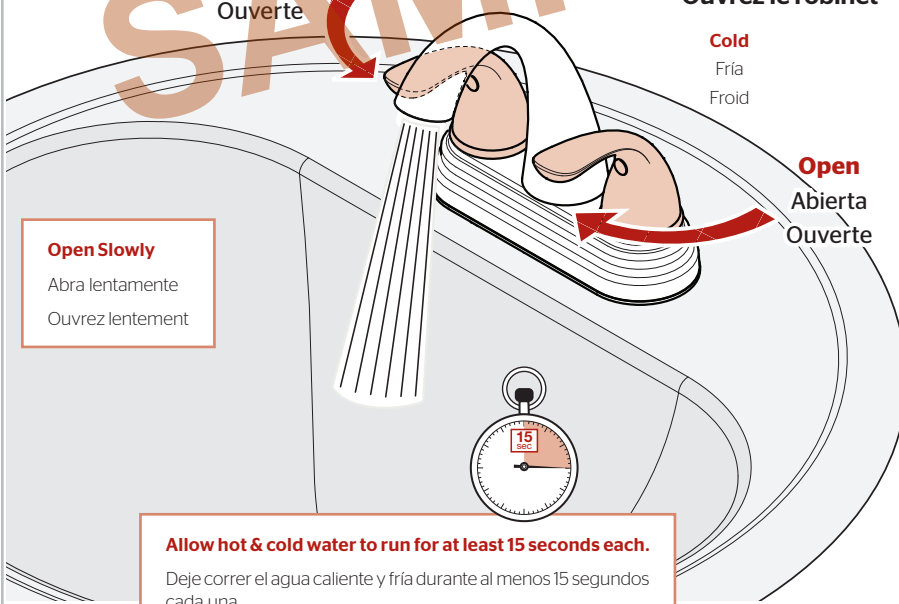

Allow hot & cold water to run for at least 15 seconds each.

Deje correr el agua caliente y fría durante al menos 15 segundos cada una.

Laissez couler l'eau chaude et l'eau froide pendant au moins 15 secondes.

8D

Reinstall Aerator

Reinstale el aereador

Réinstallez l'aérateur

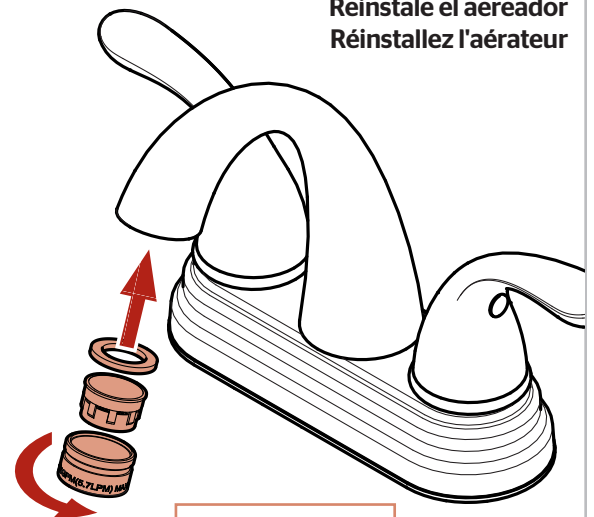

Hand Tighten

Apriete con la mano
Serrez manuellement

For Additional Installation Help:

Para la instalación adicionales de ayuda:

Pour les aides supplémentaires à l'installation:

Pfister®

1-800-PFAUCET (732-8238)
pfisterfaucets.com