

SPECIFICATIONS

**VITA BELLA
PULLS**

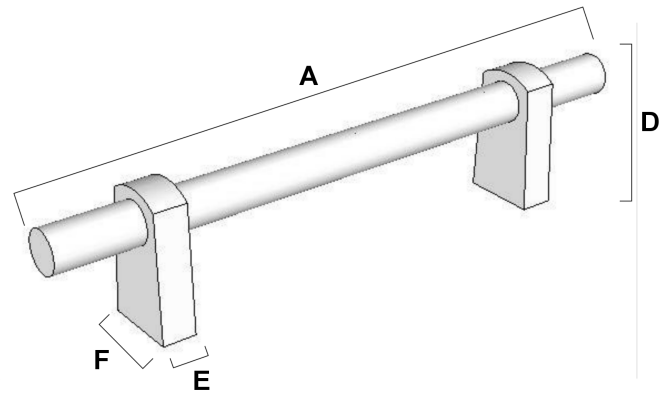

FEATURES

Transitional styling
Multiple finishes
Concealed installation

WARRANTY

Limited lifetime

FINISHES

Matte Black (MB)
Champagne (CHP)
Matte Nickel (MN)
Champagne/Matte Black (CHP/MB)
Matte Nickel/Matte Black (MN/MB)

MATERIAL

Aluminum

Item#	A	B	C	D	E (L)	F (W)
A2801-3	4 31/32"	3"	5/16"	1 1/4"	1/4"	11/16"
A2801-35	5 12/32"	3 1/2"	5/16"	1 1/4"	1/4"	11/16"
A2801-4	5 31/32"	4"	5/16"	1 1/4"	1/4"	11/16"
A2801-6	7 31/32"	6"	5/16"	1 1/4"	1/4"	11/16"
A2801-8	9 31/32"	8"	5/16"	1 1/4"	1/4"	11/16"
A2801-12	13 31/32"	12"	5/16"	1 1/4"	1/4"	11/16"
A2801-18	19 31/32"	18"	5/16"	1 1/4"	1/4"	11/16"

KEY:

- A - Overall Length
- B - Center to Center
- C - Width
- D - Projection
- E - Mount Length
- F - Mount Width

NOTE: Dimensions and specifications are subject to change without notice.